

MONTÁŽNÍ NÁVOD

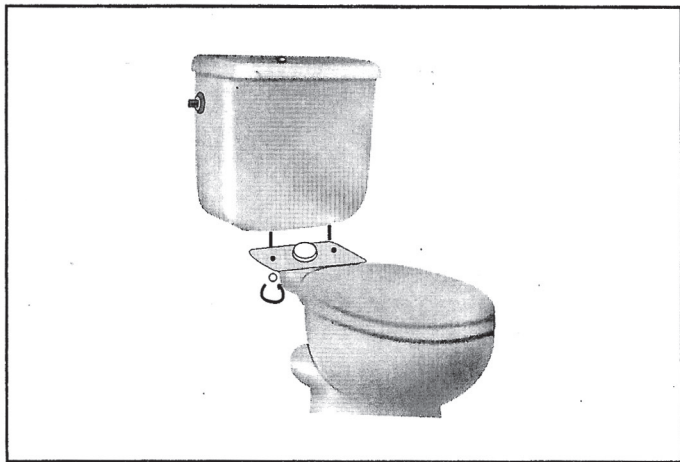

1. Připojte nádržku k míse.

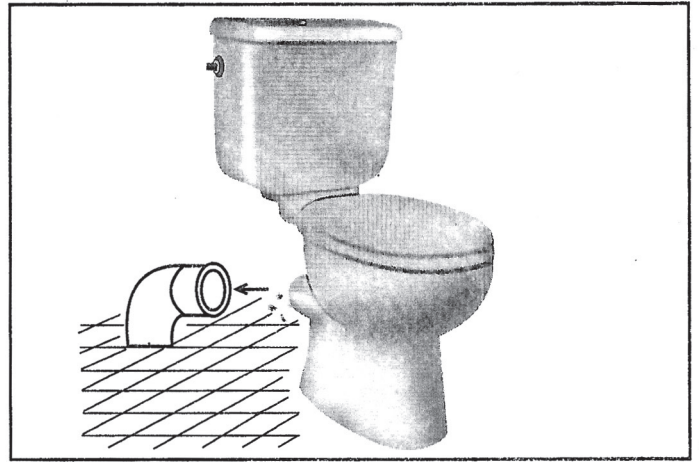

2. Napojte WC na odpad.

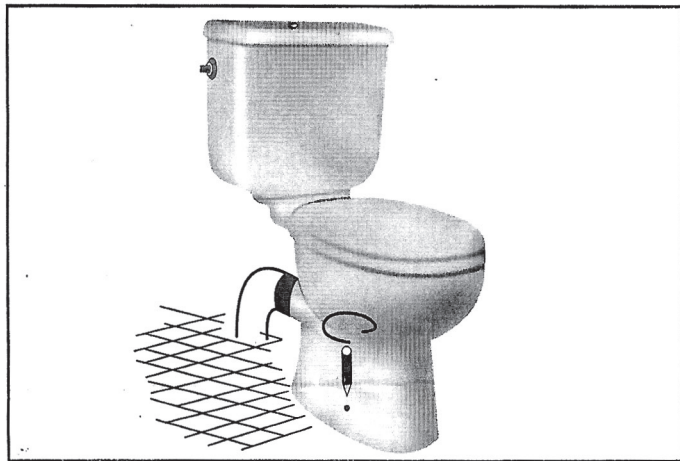

3. Označte si na podlaze otvory.

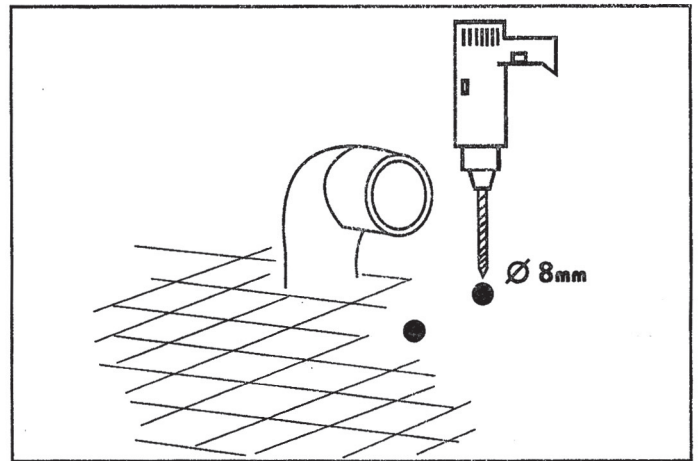

4. Vyvrtějte otvory o Ø 8 mm pro hmoždinky.

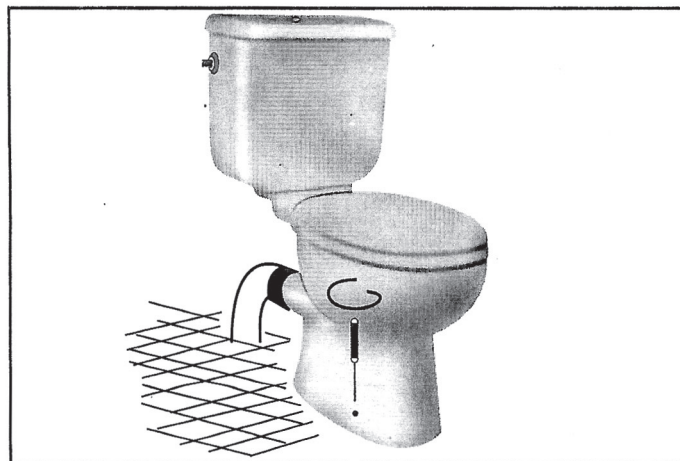

5. Přišroubujte WC mísu k podlaze.

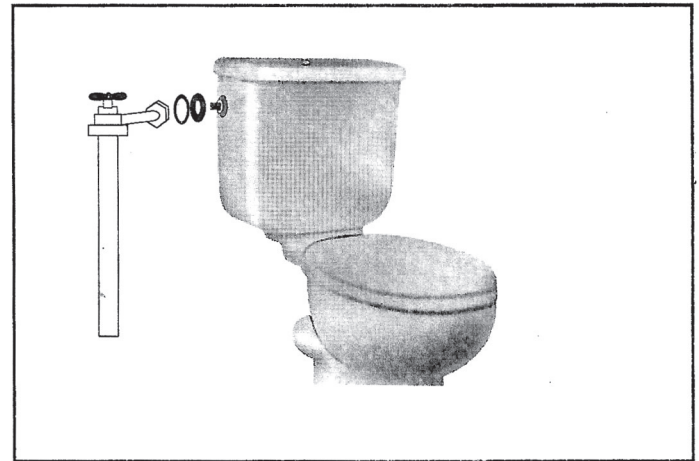

6. Připojte vodu.

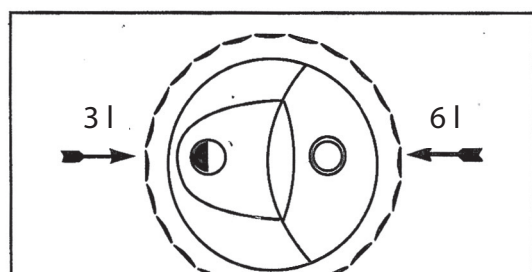

Úspora vody