

F (1:1)

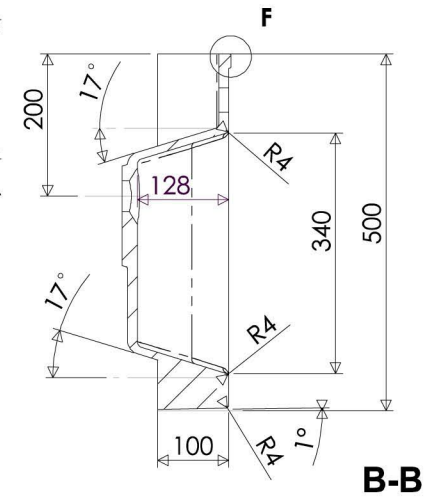

B-B

Nylonbussning M5 (2x)

**68091**